

Suggested placements of lights for Strips Trio

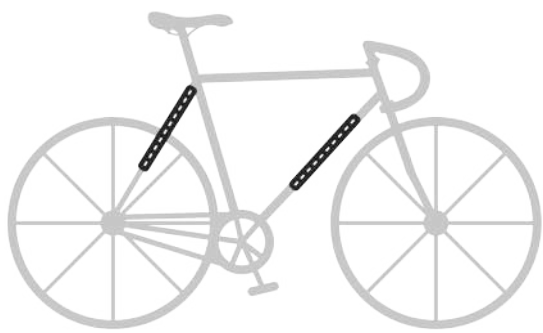

Bike

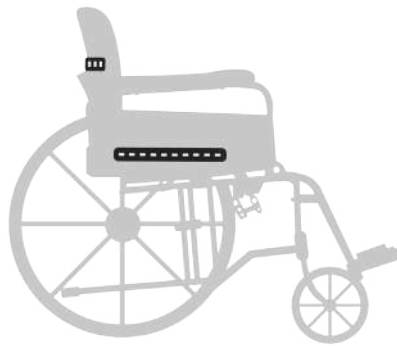

Manual Wheelchair

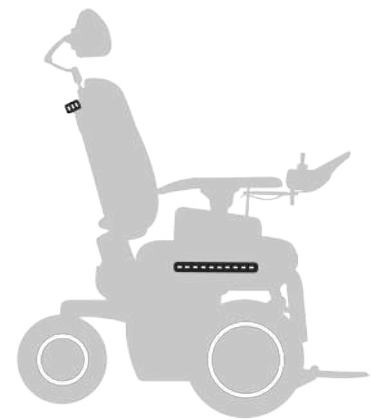

Electric Wheelchair

Contents & Instructions

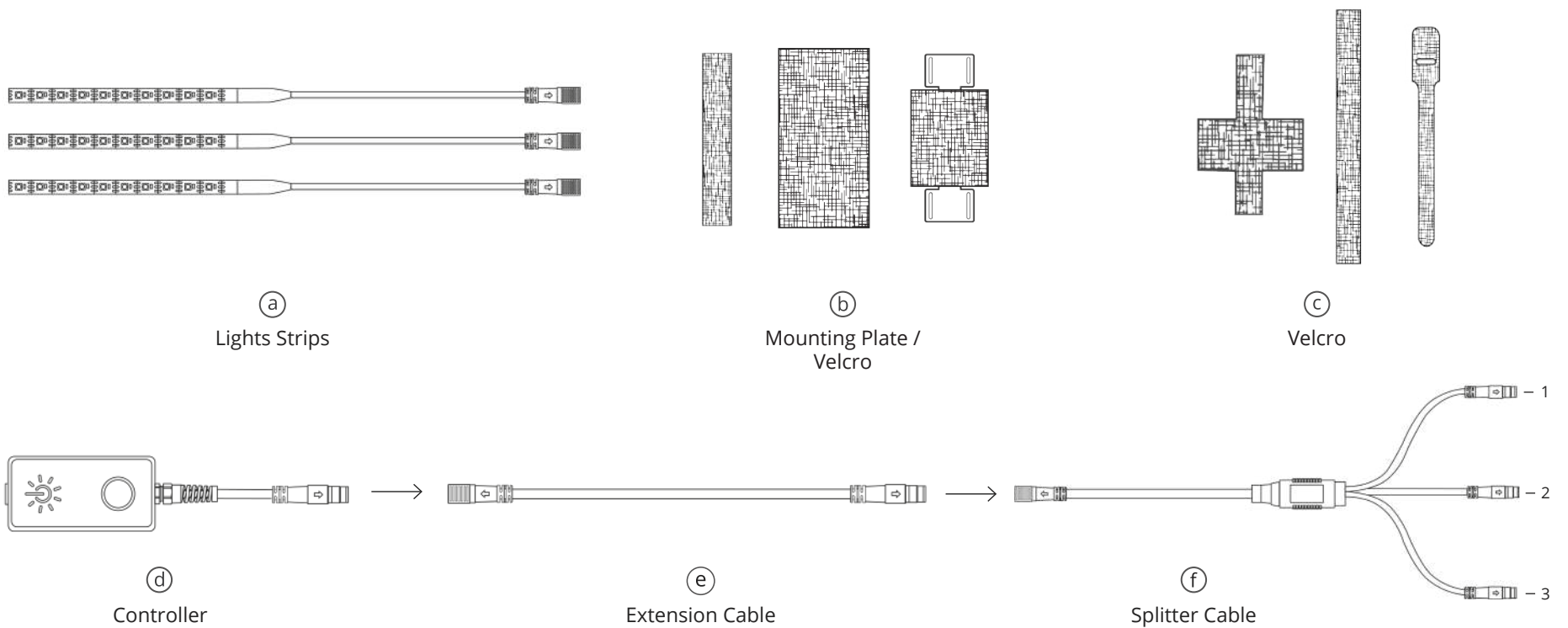

1 Mounting the Controller

(b) + (c) + (d)

Select a location to mount the controller. The controller can be mounted on a tube frame, using the included mounting plate, or on a flat surface such as a side panel. Make sure that the controller is easy to reach when using your mobility device and that the charging port is accessible for charging.

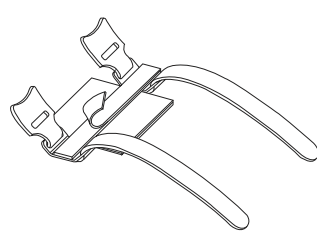

Remove the protective backing from the velcro strip. This prevents the plate from rotating once it is mounted to the frame.

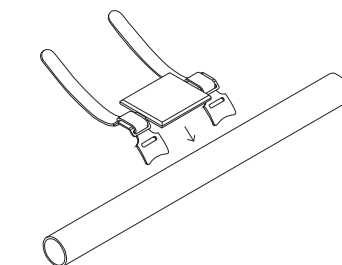

Position the mounting plate on the frame.

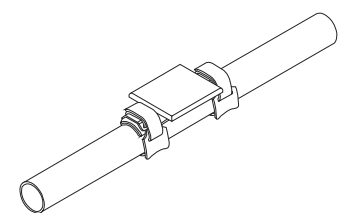

Wrap the velcro straps so the plate sits snugly on the frame. The mounting plate has a looped velcro surface that the hooked velcro of the controller can attach to.

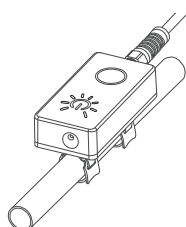

Attach Controller

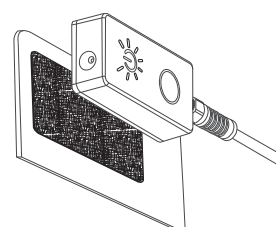

To mount the controller to a flat surface, adhere a looped velcro swatch to the desired surface. The controller can then be attached to the swatch.

2 Placing the Lights

(a) + (b)

The Strip lights can be adhered to virtually any surface—curved or flat—using the included adhesive velcro pieces, to provide excellent ground level illumination. We suggest mounting the Strips on opposing sides of your device, for a symmetrical side-lighting effect.

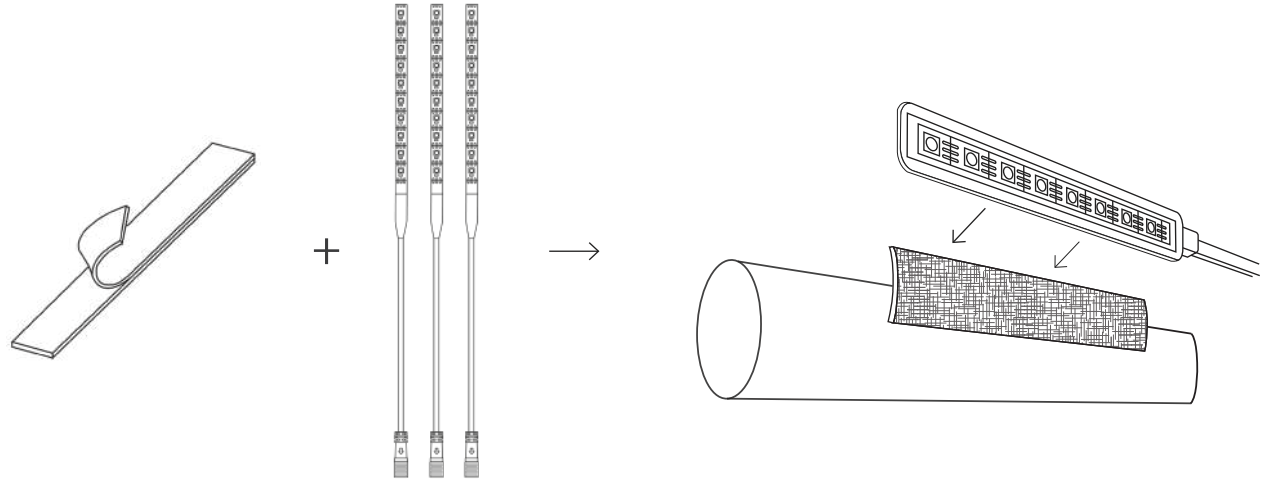

3 Cable connection and management

(a) + (c) + (d)
(e) + (f)

Run the cables from the Strip lights to the 3-way splitter cable. Connect the cables by aligning the white dot on the male and female ends and pressing together firmly. Connect the single splitter cable to the controller. Make sure the cables do not interfere with the operation of your mobility device.

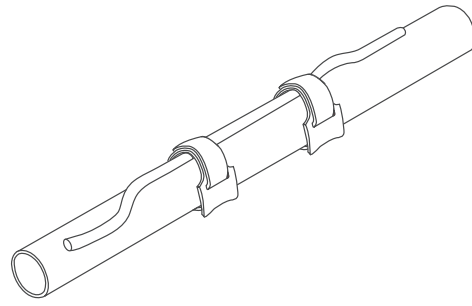

Use velcro straps to prevent any loose cables from snagging on objects.

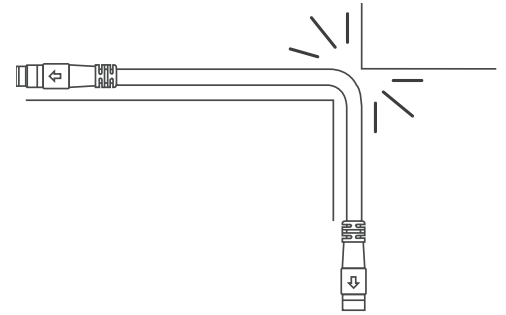

****CAUTION**** Avoid pinch points and hinges

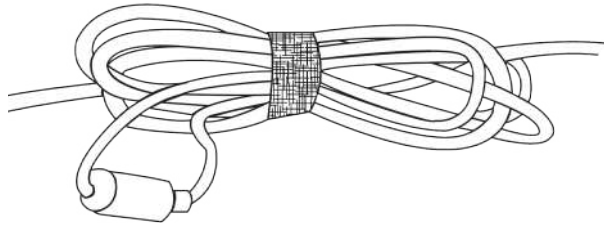

Neatly bundle any loose cables and secure with a velcro strap.

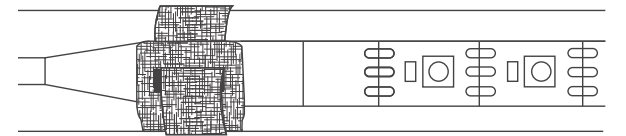

Install a velcro strap at all cable connections and at the top of the Strip lights, if possible, to reduce strain on these junctions.